

## SIT timing pulleys - TOP DRIVE® HTD

TOP DRIVE® HTD pulleys have a different design from the traditional toothed pulleys.

The axial grooves are designed to allow the belt teeth to catch the pulley teeth with negligible friction.

TOP DRIVE® HTD pulleys are available with full hub and for assembly with SER-SIT® taper bushing.

**Solid hub**

Material: aluminum/cast iron/steel.

Finishing: protective surface treatment.

Pitch:

- 3M
- 5M
- 8M
- 14M

**For mounting taper bushing SER-SIT®**

Material: cast iron/steel.

Finishing: protective surface treatment.

Pitch:

- 5M
- 8M
- 14M

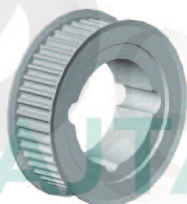
**Special executions**

Upon request, SIT is able to design and manufacture any type of pulley based on customer requirements.

For peripheral speed exceeding 33 m/s it is strongly recommended to use steel as material of construction.

$$\text{peripheral speed [m/s]} = \frac{\text{pulley diameter [mm]} \cdot \text{rpm}}{19100}$$

In order to reduce the system weight, the pulleys can be manufactured from light metals; in this case the lifetime will be reduced when compared to the standard because the nylon belt coating has a slightly abrasive effect. This disadvantage can be reduced with a high thickness anodization coating of the teeth.

**Flanged pulleys**

Timing belts, when in motion, have a slight lateral displacement. It is therefore necessary to use at least one flanged pulley to prevent the belt jumping out of the pulley.

Usually, in order to reduce the costs, the flanged pulley is the one with the smaller diameter.

In any case, when the distance of the axes is greater than 8 times the diameter of the small pulley, or when the transmission is working on shafts arranged in a position that is not horizontal one, both pulleys have to be flanged.

**TOLERANCES****Pulley diameter tolerances**

External Diameter [mm]	Tolerances [mm]
up to 25,4	-0,00 +0,05
from 25,5 to 50,8	-0,00 +0,08
from 50,9 to 101,6	-0,00 +0,10
from 101,7 to 177,8	-0,00 +0,13
from 177,9 to 304,8	-0,00 +0,15
from 304,9 to 508,0	-0,00 +0,18
more than 508,1	-0,00 +0,25

**Radial circular runout**

External Diameter [mm]	Measured total eccentricity [mm]
up to 200	0,13
more than 200	add 0,0005 for any mm more than 200

**Cylindricity tolerance**

Pulley width	Tolerances
for any 100 mm	0,1 mm without exceeding the external diameter tolerance

**Protective coating**

All (steel and cast iron) pulleys are treated with surface process that gives greater resistance against oxidizing agents. This treatment does not modify the profile or the dimensions of the pulleys.

On request SIT can provide a wide range of special coating, related to the customer specific needs or environmental critical conditions.

**Note**

Due to a constant improvement of our products, technical data of the pulleys may be subject to changes. For technical and production reasons, in some cases materials other than those indicated in the catalogue may be used. For confirmation of the material actually available, please contact customer service.

# Dimensions of timing pulleys TOP DRIVE® HTD - solid hub pitches 3M - 5M - 8M - 14M



Part Number	HD 48 -8M 20
HTD timing pulleys - solid hub	
Number of teeth	
Pitch	
Belt width in mm	

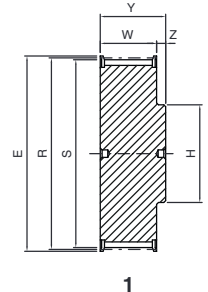

3M

## HD ... -3M09

Code	Teeth nr.	Type	E [mm]	R [mm]	S [mm]	H [mm]	W [mm]	Y [mm]	Z [mm]	Flange	Material
HD 10 - 3M 09	10	2	13,0	9,55	8,79	13,0	10,2	17,5	7,3	with flanges	aluminum
HD 12 - 3M 09	12	2	15,0	11,46	10,70	15,0	10,2	17,5	7,3		
HD 14 - 3M 09	14	2	16,0	13,37	12,61	18,0	10,2	17,5	7,3		
HD 15 - 3M 09	15	2	17,5	14,32	13,56	18,0	10,2	17,5	7,3		
HD 16 - 3M 09	16	1	17,5	15,28	14,52	10,0	12,8	20,6	7,8		
HD 18 - 3M 09	18	1	20,0	17,19	16,43	10,0	12,8	20,6	7,8		
HD 20 - 3M 09	20	1	23,0	19,10	18,34	13,0	12,8	20,6	7,8		
HD 21 - 3M 09	21	1	25,0	20,05	19,29	13,0	12,8	20,6	7,8		
HD 22 - 3M 09	22	1	25,0	21,01	20,25	13,0	12,8	20,6	7,8		
HD 24 - 3M 09	24	1	25,0	22,92	22,16	14,0	12,8	20,6	7,8		
HD 26 - 3M 09	26	1	28,0	24,83	24,07	16,0	12,8	20,6	7,8		
HD 28 - 3M 09	28	1	32,0	26,74	25,98	18,0	12,8	20,6	7,8		
HD 30 - 3M 09	30	1	32,0	28,65	27,89	20,0	12,8	20,6	7,8		
HD 32 - 3M 09	32	1	36,0	30,56	29,80	22,0	12,8	20,6	7,8		
HD 36 - 3M 09	36	1	39,0	34,38	33,62	26,0	13,4	22,2	8,8		
HD 40 - 3M 09	40	1	42,0	38,20	37,44	28,0	13,4	22,2	8,8		
HD 44 - 3M 09	44	1	48,0	42,02	41,26	33,0	13,4	22,2	8,8		
HD 48 - 3M 09	48	1A	-	45,84	45,08	33,0	13,4	22,2	8,8		
HD 60 - 3M 09	60	1A	-	57,30	56,54	33,0	13,4	22,2	8,8		
HD 72 - 3M 09	72	1A	-	68,75	67,99	33,0	13,4	22,2	8,8		

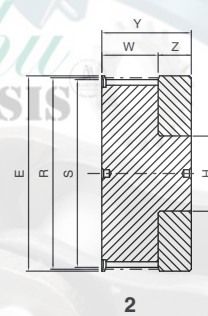
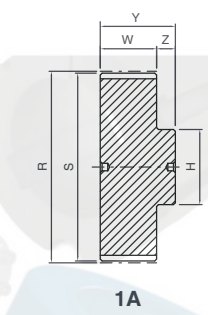

## HD ... -3M15

3M

Code	Teeth nr.	Type	E [mm]	R [mm]	S [mm]	H [mm]	W [mm]	Y [mm]	Z [mm]	Flange	Material
HD 10 - 3M 15	10	2	13,0	9,55	8,79	13,0	17,0	26,0	9,0	with flanges	aluminum
HD 12 - 3M 15	12	2	15,0	11,46	10,70	15,0	17,0	26,0	9,0		
HD 14 - 3M 15	14	2	16,0	13,37	12,61	18,0	17,0	26,0	9,0		
HD 15 - 3M 15	15	2	17,5	14,32	13,56	18,0	17,0	26,0	9,0		
HD 16 - 3M 15	16	1	17,5	15,28	14,52	10,0	19,5	26,0	6,5		
HD 18 - 3M 15	18	1	20,0	17,19	16,43	10,0	19,5	26,0	6,5		
HD 20 - 3M 15	20	1	23,0	19,10	18,34	13,0	19,5	26,0	6,5		
HD 21 - 3M 15	21	1	25,0	20,05	19,29	13,0	19,5	26,0	6,5		
HD 22 - 3M 15	22	1	25,0	21,01	20,25	13,0	19,5	26,0	6,5		
HD 24 - 3M 15	24	1	25,0	22,92	22,16	14,0	19,5	26,0	6,5		
HD 26 - 3M 15	26	1	28,0	24,83	24,07	16,0	19,5	26,0	6,5		
HD 28 - 3M 15	28	1	32,0	26,74	25,98	18,0	19,5	26,0	6,5		
HD 30 - 3M 15	30	1	32,0	28,65	27,89	20,0	19,5	26,0	6,5		
HD 32 - 3M 15	32	1	36,0	30,56	29,80	22,0	19,5	26,0	6,5		
HD 36 - 3M 15	36	1	39,0	34,38	33,62	26,0	20,0	30,0	10,0		
HD 40 - 3M 15	40	1	42,0	38,20	37,44	28,0	20,0	30,0	10,0		
HD 44 - 3M 15	44	1	48,0	42,02	41,26	33,0	20,0	30,0	10,0		
HD 48 - 3M 15	48	1A	-	45,84	45,08	33,0	20,0	30,0	10,0		
HD 60 - 3M 15	60	1A	-	57,30	56,54	33,0	20,0	30,0	10,0		
HD 72 - 3M 15	72	1A	-	68,75	67,99	33,0	20,0	30,0	10,0		

# Dimensions of timing pulleys TOP DRIVE® HTD - solid hub



## HD ... -5M09

5M

Code	Teeth nr.	Type	E [mm]	R [mm]	S [mm]	U [mm]	H [mm]	W [mm]	Y [mm]	Z [mm]	Flange	Material
HD 12 - 5M 09	12	1	23,0	19,10	17,96	-	12,0	14,5	20,0	5,5	with flanges	steel
HD 14 - 5M 09	14	1	25,0	22,28	21,14	-	13,0	14,5	20,0	5,5		
HD 15 - 5M 09	15	1	28,0	23,87	22,73	-	16,0	14,5	20,0	5,5		
HD 16 - 5M 09	16	1	28,0	25,47	24,32	-	16,5	14,5	20,0	5,5		
HD 18 - 5M 09	18	1	32,0	28,65	27,51	-	20,0	14,5	20,0	5,5		
HD 20 - 5M 09	20	1	36,0	31,83	30,69	-	23,0	14,5	22,5	8,0		
HD 21 - 5M 09	21	1	38,0	33,42	32,28	-	24,0	14,5	22,5	8,0		
HD 22 - 5M 09	22	1	39,0	35,01	33,87	-	25,5	14,5	22,5	8,0		
HD 24 - 5M 09	24	1	42,0	38,19	37,06	-	27,0	14,5	22,5	8,0		
HD 26 - 5M 09	26	1	44,0	41,38	40,24	-	30,0	14,5	22,5	8,0		
HD 28 - 5M 09	28	1	48,0	44,56	43,42	-	30,5	14,5	22,5	8,0		
HD 30 - 5M 09	30	1	51,0	47,75	46,61	-	35,0	14,5	22,5	8,0		
HD 32 - 5M 09	32	1	54,0	50,93	49,79	-	38,0	14,5	22,5	8,0		
HD 36 - 5M 09	36	1	60,0	57,30	56,16	-	38,0	14,5	22,5	8,0		
HD 40 - 5M 09	40	1	71,0	63,66	62,52	-	38,0	14,5	22,5	8,0		
HD 44 - 5M 09	44	1A	-	70,03	68,89	-	38,0	14,5	25,5	11,0		
HD 48 - 5M 09	48	1A	-	76,39	75,25	-	45,0	14,5	25,5	11,0		
HD 60 - 5M 09	60	1A	-	95,49	94,35	-	45,0	14,5	25,5	11,0		
HD 72 - 5M 09	72	3A	-	114,59	113,45	90	45,0	14,5	25,5	11,0		

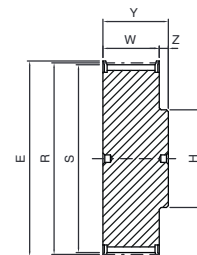

1

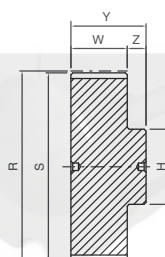

1A

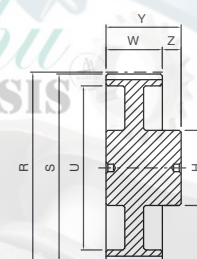

3A

## HD ... -5M15

5M

Code	Teeth nr.	Type	E [mm]	R [mm]	S [mm]	U [mm]	H [mm]	W [mm]	Y [mm]	Z [mm]	Flange	Material
HD 12 - 5M 15	12	1	23,0	19,10	17,96	-	12,0	20,5	26,0	5,5	with flanges	steel
HD 14 - 5M 15	14	1	25,0	22,28	21,14	-	13,0	20,5	26,0	5,5		
HD 15 - 5M 15	15	1	28,0	23,87	22,73	-	16,0	20,5	26,0	5,5		
HD 16 - 5M 15	16	1	28,0	25,47	24,32	-	16,5	20,5	26,0	5,5		
HD 18 - 5M 15	18	1	32,0	28,65	27,51	-	20,0	20,5	26,0	5,5		
HD 20 - 5M 15	20	1	36,0	31,83	30,69	-	23,0	20,5	26,0	5,5		
HD 21 - 5M 15	21	1	38,0	33,42	32,28	-	24,0	20,5	26,0	5,5		
HD 22 - 5M 15	22	1	39,0	35,01	33,87	-	25,5	20,5	26,0	5,5		
HD 24 - 5M 15	24	1	42,0	38,19	37,06	-	27,0	20,5	28,0	7,5		
HD 26 - 5M 15	26	1	44,0	41,38	40,24	-	30,0	20,5	28,0	7,5		
HD 28 - 5M 15	28	1	48,0	44,56	43,42	-	30,5	20,5	28,0	7,5		
HD 30 - 5M 15	30	1	51,0	47,75	46,61	-	35,0	20,5	28,0	7,5		
HD 32 - 5M 15	32	1	54,0	50,93	49,79	-	38,0	20,5	28,0	7,5		
HD 36 - 5M 15	36	1	60,0	57,30	56,16	-	38,0	20,5	28,0	7,5		
HD 40 - 5M 15	40	1	71,0	63,66	62,52	-	38,0	20,5	28,0	7,5		
HD 44 - 5M 15	44	1A	-	70,03	68,89	-	38,0	20,5	30,0	9,5		
HD 48 - 5M 15	48	1A	-	76,39	75,25	-	45,0	20,5	30,0	9,5		
HD 60 - 5M 15	60	1A	-	95,49	94,35	-	50,0	20,5	30,0	9,5		
HD 72 - 5M 15	72	3A	-	114,59	113,45	90	50,0	20,5	30,0	9,5		

# Dimensions of timing pulleys TOP DRIVE® HTD - solid hub



## HD ... -5M25

5M

Code	Teeth nr.	Type	E [mm]	R [mm]	S [mm]	U [mm]	H [mm]	W [mm]	Y [mm]	Z [mm]	Flange	Material
HD 12 - 5M 25	127	1	23,0	19,10	17,96	-	12,0	30,0	36,0	6,0	with flanges	steel
HD 14 - 5M 25	14	1	25,0	22,28	21,14	-	13,0	30,0	36,0	6,0		
HD 15 - 5M 25	15	1	28,0	23,87	22,73	-	16,0	30,0	36,0	6,0		
HD 16 - 5M 25	16	1	28,0	25,47	24,32	-	16,5	30,0	36,0	6,0		
HD 18 - 5M 25	18	1	32,0	28,65	27,51	-	20,0	30,0	36,0	6,0		
HD 20 - 5M 25	20	1	36,0	31,83	30,69	-	23,0	30,0	36,0	6,0		
HD 21 - 5M 25	21	1	38,0	33,42	32,28	-	24,0	30,0	38,0	8,0		
HD 22 - 5M 25	22	1	39,0	35,01	33,87	-	25,5	30,0	38,0	8,0		
HD 24 - 5M 25	24	1	42,0	38,19	37,06	-	27,0	30,0	38,0	8,0		
HD 26 - 5M 25	26	1	44,0	41,38	40,24	-	30,0	30,0	38,0	8,0		
HD 28 - 5M 25	28	1	48,0	44,56	43,42	-	30,5	30,0	38,0	8,0		
HD 30 - 5M 25	30	1	51,0	47,75	46,61	-	35,0	30,0	38,0	8,0		
HD 32 - 5M 25	32	1	54,0	50,93	49,79	-	38,0	30,0	38,0	8,0		
HD 36 - 5M 25	36	1	60,0	57,30	56,16	-	38,0	30,0	38,0	8,0		
HD 40 - 5M 25	40	1	71,0	63,66	62,52	-	38,0	30,0	38,0	8,0		
HD 44 - 5M 25	44	1A	-	70,03	68,89	-	38,0	30,0	40,0	10,0		
HD 48 - 5M 25	48	1A	-	76,39	75,25	-	45,0	30,0	40,0	10,0		
HD 60 - 5M 25	60	1A	-	95,49	94,35	-	50,0	30,0	40,0	10,0		
HD 72 - 5M 25	72	3A	-	114,59	113,45	90	50,0	30,0	40,0	10,0		
											without flanges	aluminum

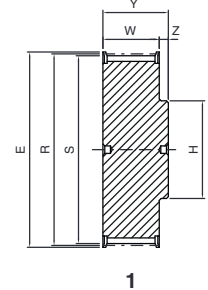

1

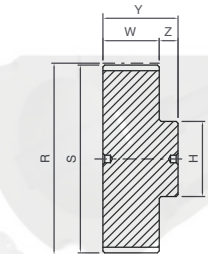

1A

## HD ... -8M20

8M

Code	Teeth nr.	Type	E [mm]	R [mm]	S [mm]	U [mm]	H [mm]	d [mm]	W [mm]	Y [mm]	Z [mm]	Flange	Material
HD 18 - 8M 20	18	1	51,0	45,84	44,46	-	32,0	-	28	38	10	with flanges	steel
HD 20 - 8M 20	20	1	57,0	50,93	49,56	-	36,0	-	28	38	10		
HD 22 - 8M 20	22	1	60,0	56,02	54,65	-	43,0	-	28	38	10		
HD 24 - 8M 20	24	1	66,0	61,12	59,74	-	45,0	-	28	38	10		
HD 26 - 8M 20	26	1	70,0	66,21	64,84	-	48,0	-	28	38	10		
HD 28 - 8M 20	28	1	75,0	71,30	70,08	-	55,0	-	28	38	10		
HD 30 - 8M 20	30	1	83,0	76,39	75,13	-	60,0	-	28	38	10		
HD 32 - 8M 20	32	1	87,0	81,49	80,16	-	64,0	-	28	38	10		
HD 34 - 8M 20	34	1	91,0	86,58	85,21	-	70,0	-	28	38	10		
HD 36 - 8M 20	36	1	97,0	91,67	90,30	-	75,0	-	28	38	10		
HD 38 - 8M 20	38	1	102,0	96,77	95,39	-	80,0	-	28	38	10		
HD 40 - 8M 20	40	1	106,0	101,86	100,49	-	85,0	-	28	38	10		
HD 44 - 8M 20	44	1	120,0	112,05	110,67	-	96,0	-	28	38	10		
HD 48 - 8M 20	48	1	128,0	122,23	120,86	-	104,0	-	28	38	10		
HD 56 - 8M 20	56	5	150,0	142,60	141,23	117	80,0	12	28	38	10		
HD 60 - 8M 20	60	5	158,0	152,79	151,42	127	80,0	12	28	38	10		
HD 64 - 8M 20	64	5	168,0	162,97	161,60	137	80,0	12	28	38	10		
HD 72 - 8M 20	72	5	192,0	183,35	181,97	158	80,0	12	28	38	10		
HD 80 - 8M 20	80	5A	-	203,72	202,35	179	90,0	12	28	38	10		
HD 84 - 8M 20	84	5A	-	213,90	212,53	190	90,0	12	28	38	10		
HD 90 - 8M 20	90	5A	-	229,18	227,81	204	90,0	12	28	38	10		
HD 112 - 8M 20	112	5B	-	285,21	283,83	260	90,0	18	28	38	10		
HD 144 - 8M 20	144	5B	-	366,69	365,32	342	90,0	20	28	38	10		
HD 168 - 8M 20	168	5B	-	427,80	426,44	403	100,0	20	28	38	10		
HD 192 - 8M 20	192	5B	-	488,92	487,54	465	100,0	20	28	38	10		
												without flanges	cast iron

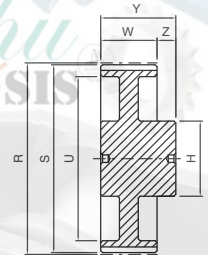

3A

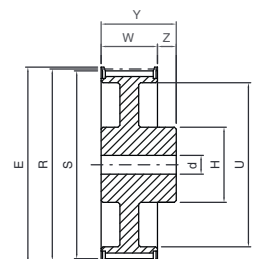

5

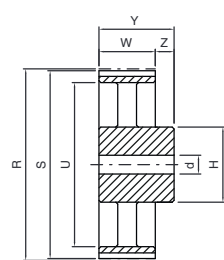

5B

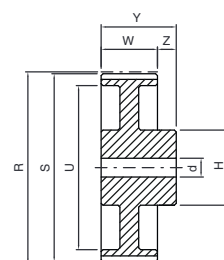

5A

# Dimensions of timing pulleys TOP DRIVE® HTD - solid hub



TIMING PULLEYS - HD

## HD ... -8M30

8M

Code	Teeth nr.	Type	E [mm]	R [mm]	S [mm]	U [mm]	H [mm]	d [mm]	W [mm]	Y [mm]	Z [mm]	Flange	Material
HD 18 - 8M 30	18	1	51,0	45,84	44,46	-	32,0	-	38	48	10	with flanges	steel
HD 20 - 8M 30	20	1	57,0	50,93	49,56	-	36,0	-	38	48	10		
HD 22 - 8M 30	22	1	60,0	56,02	54,65	-	43,0	-	38	48	10		
HD 24 - 8M 30	24	1	66,0	61,12	59,74	-	45,0	-	38	48	10		
HD 26 - 8M 30	26	1	70,0	66,21	64,84	-	48,0	-	38	48	10		
HD 28 - 8M 30	28	1	75,0	71,30	70,08	-	55,0	-	38	48	10		
HD 30 - 8M 30	30	1	83,0	76,39	75,13	-	60,0	-	38	48	10		
HD 32 - 8M 30	32	1	87,0	81,49	80,16	-	64,0	-	38	48	10		
HD 34 - 8M 30	34	1	91,0	86,58	85,21	-	70,0	-	38	48	10		
HD 36 - 8M 30	36	1	97,0	91,67	90,30	-	75,0	-	38	48	10		
HD 38 - 8M 30	38	1	102,0	96,77	95,39	-	80,0	-	38	48	10		
HD 40 - 8M 30	40	1	106,0	101,86	100,49	-	85,0	-	38	48	10		
HD 44 - 8M 30	44	1	120,0	112,05	110,67	-	96,0	-	38	48	10		
HD 48 - 8M 30	48	1	128,0	122,23	120,86	-	104,0	-	38	48	10		
HD 56 - 8M 30	56	5	150,0	142,60	141,23	117	90,0	12	38	48	10		
HD 60 - 8M 30	60	5	158,0	152,79	151,42	127	90,0	12	38	48	10		
HD 64 - 8M 30	64	5	168,0	162,97	161,60	137	90,0	12	38	48	10		
HD 72 - 8M 30	72	5	192,0	183,35	181,97	158	95,0	12	38	48	10		
HD 80 - 8M 30	80	5A	-	203,72	202,35	179	100,0	12	38	48	10		
HD 84 - 8M 30	84	5A	-	213,90	212,53	190	100,0	12	38	48	10		
HD 90 - 8M 30	90	5A	-	229,18	227,81	204	100,0	12	38	48	10		
HD 112 - 8M 30	112	5B	-	285,21	283,83	260	100,0	18	38	48	10		
HD 144 - 8M 30	144	5B	-	366,69	365,32	342	100,0	20	38	48	10		
HD 168 - 8M 30	168	5B	-	427,80	426,44	403	100,0	20	38	48	10		
HD 192 - 8M 30	192	5B	-	488,92	487,54	465	100,0	20	38	48	10		

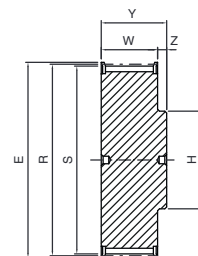

1

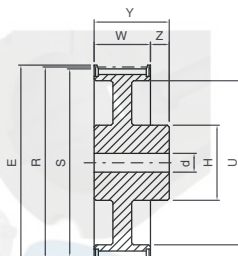

5

## HD ... -8M50

8M

Code	Teeth nr.	Type	E [mm]	R [mm]	S [mm]	U [mm]	H [mm]	d [mm]	W [mm]	Y [mm]	Z [mm]	Flange	Material
HD 18 - 8M 50	18	1	51,0	45,84	44,46	-	32,0	-	60	70	10	with flanges	steel
HD 20 - 8M 50	20	1	57,0	50,93	49,56	-	36,0	-	60	70	10		
HD 22 - 8M 50	22	1	60,0	56,02	54,65	-	43,0	-	60	70	10		
HD 24 - 8M 50	24	1	66,0	61,12	59,74	-	49,0	-	60	70	10		
HD 26 - 8M 50	26	1	70,0	66,21	64,84	-	50,0	-	60	70	10		
HD 28 - 8M 50	28	1	75,0	71,30	70,08	-	55,0	-	60	70	10		
HD 30 - 8M 50	30	1	83,0	76,39	75,13	-	60,0	-	60	70	10		
HD 32 - 8M 50	32	1	87,0	81,49	80,16	-	64,0	-	60	70	10		
HD 34 - 8M 50	34	1	91,0	86,58	85,21	-	70,0	-	60	70	10		
HD 36 - 8M 50	36	1	97,0	91,67	90,30	-	75,0	-	60	70	10		
HD 38 - 8M 50	38	1	102,0	96,77	95,39	-	80,0	-	60	70	10		
HD 40 - 8M 50	40	1	106,0	101,86	100,49	-	85,0	-	60	70	10		
HD 44 - 8M 50	44	1	120,0	112,05	110,67	-	96,0	-	60	70	10		
HD 48 - 8M 50	48	1	128,0	122,23	120,86	-	104,0	-	60	70	10		
HD 56 - 8M 50	56	7	150,0	142,60	141,23	117	90,0	18	60	60	-		
HD 60 - 8M 50	60	7	158,0	152,79	151,42	127	100,0	18	60	60	-		
HD 64 - 8M 50	64	7	168,0	162,97	161,60	137	100,0	18	60	60	-		
HD 72 - 8M 50	72	7	192,0	183,35	181,97	158	100,0	18	60	60	-		
HD 80 - 8M 50	80	7A	-	203,72	202,35	179	110,0	18	60	60	-		
HD 84 - 8M 50	84	7B	-	213,90	212,53	190	110,0	18	60	60	-		
HD 90 - 8M 50	90	7B	-	229,18	227,81	204	110,0	18	60	60	-		
HD 112 - 8M 50	112	7B	-	285,21	283,83	260	110,0	18	60	60	-		
HD 144 - 8M 50	144	7B	-	366,69	365,32	342	110,0	20	60	60	-		
HD 168 - 8M 50	168	7B	-	427,80	426,44	403	120,0	20	60	60	-		
HD 192 - 8M 50	192	7B	-	488,92	487,54	465	130,0	20	60	60	-		

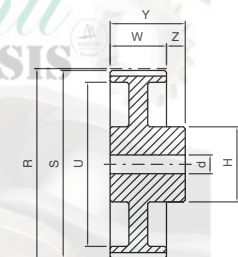

5A

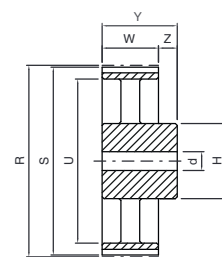

5B

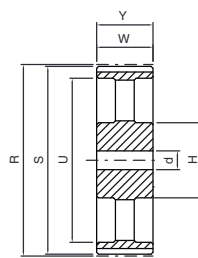

7B

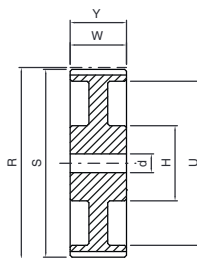

7A

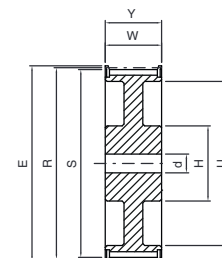

7

# Dimensions of timing pulleys TOP DRIVE® HTD - solid hub



## HD ... -8M85

8M

Code	Teeth nr.	Type	E [mm]	R [mm]	S [mm]	U [mm]	H [mm]	d [mm]	W [mm]	Y [mm]	Z [mm]	Flange	Material
HD 22 - 8M 85	22	1	60,0	56,02	54,65	-	43,0	-	95	105	10	with flanges	steel
HD 24 - 8M 85	24	1	66,0	61,12	59,74	-	45,0	-	95	105	10		
HD 26 - 8M 85	26	1	70,0	66,21	64,84	-	48,0	-	95	105	10		
HD 28 - 8M 85	28	1	75,0	71,30	70,08	-	55,0	-	95	105	10		
HD 30 - 8M 85	30	1	83,0	76,39	75,13	-	60,0	-	95	105	10		
HD 32 - 8M 85	32	1	87,0	81,49	80,16	-	64,0	-	95	105	10		
HD 34 - 8M 85	34	1	91,0	86,58	85,21	-	70,0	-	95	105	10		
HD 36 - 8M 85	36	1	97,0	91,67	90,30	-	75,0	-	95	105	10		
HD 38 - 8M 85	38	1	102,0	96,77	95,39	-	80,0	-	95	105	10		
HD 40 - 8M 85	40	1	106,0	101,86	100,49	-	85,0	-	95	105	10		
HD 44 - 8M 85	44	1	120,0	112,05	110,67	-	96,0	-	95	105	10		
HD 48 - 8M 85	48	1	128,0	122,23	120,86	-	100,0	-	95	105	10		
HD 56 - 8M 85	56	1	150,0	142,60	141,23	-	107,0	-	95	105	10		
HD 60 - 8M 85	60	1	158,0	152,79	151,42	-	132,0	-	95	105	10		
HD 64 - 8M 85	64	7	168,0	162,97	161,60	137	100,0	18	95	95	-		
HD 72 - 8M 85	72	7	192,0	183,35	181,97	158	110,0	18	95	95	-		
HD 80 - 8M 85	80	7A	-	203,72	202,35	179	110,0	20	95	95	-		
HD 84 - 8M 85	84	7A	-	213,90	212,53	190	110,0	20	95	95	-		
HD 90 - 8M 85	90	7B	-	229,18	227,81	204	110,0	20	95	95	-		
HD 112 - 8M 85	112	7B	-	285,21	283,83	260	110,0	24	95	95	-		
HD 144 - 8M 85	144	7B	-	366,69	365,32	342	120,0	24	95	95	-		
HD 168 - 8M 85	168	7B	-	427,80	426,44	403	120,0	24	95	95	-		
HD 192 - 8M 85	192	7B	-	488,92	487,54	465	130,0	24	95	95	-		

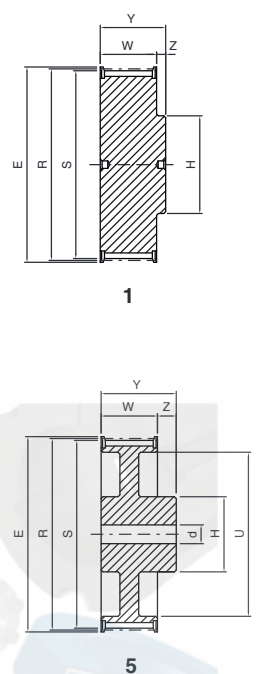

## HD ... -14M40

14M

Code	Teeth nr.	Type	E [mm]	R [mm]	S [mm]	U [mm]	H [mm]	d [mm]	W [mm]	Y [mm]	Z [mm]	Flange	Material
HD 28 - 14M 40	28	1	128,0	124,78	122,12	-	100,0	-	54	69	15	with flanges	steel
HD 29 - 14M 40	29	1	138,0	129,23	126,57	-	107,0	-	54	69	15		
HD 30 - 14M 40	30	1	138,0	133,69	130,99	-	107,0	-	54	69	15		
HD 32 - 14M 40	32	1	154,0	142,60	139,88	-	114,0	-	54	69	15		
HD 34 - 14M 40	34	1	160,0	151,51	148,79	-	122,0	-	54	69	15		
HD 36 - 14M 40	36	1	168,0	160,43	157,68	-	128,0	-	54	69	15		
HD 38 - 14M 40	38	1	183,0	169,34	166,60	-	141,0	-	54	69	15		
HD 40 - 14M 40	40	1	198,0	178,25	175,49	-	148,0	-	54	69	15		
HD 44 - 14M 40	44	5	211,0	196,08	193,28	154	120,0	24	54	69	15		
HD 48 - 14M 40	48	5	226,0	213,90	211,11	172	135,0	24	54	69	15		
HD 56 - 14M 40	56	5	256,0	249,55	246,76	207	135,0	28	54	69	15		
HD 60 - 14M 40	60	5	275,0	267,38	264,59	225	135,0	28	54	69	15		
HD 64 - 14M 40	64	5	296,0	285,21	282,41	243	135,0	28	54	69	15		
HD 72 - 14M 40	72	5B	-	320,86	318,06	279	135,0	28	54	69	15		
HD 80 - 14M 40	80	5B	-	356,51	353,71	314	135,0	28	54	69	15		
HD 84 - 14M 40	84	5B	-	374,33	371,54	332	135,0	28	54	69	15		
HD 90 - 14M 40	90	5B	-	401,07	398,28	359	135,0	28	54	69	15		
HD 112 - 14M 40	112	5B	-	499,11	496,32	457	135,0	28	54	69	15		
HD 144 - 14M 40	144	5B	-	641,71	638,92	600	135,0	28	54	69	15		

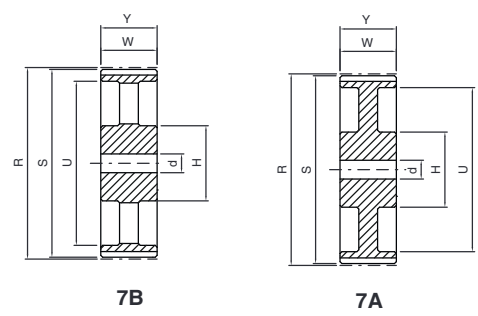
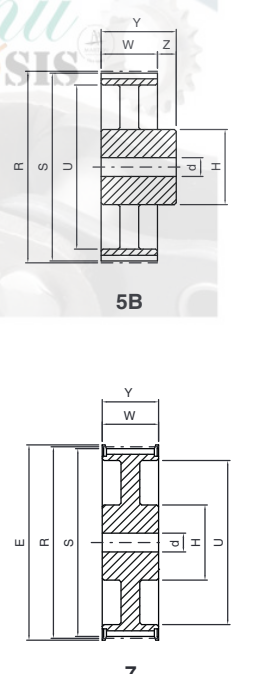

# Dimensions of timing pulleys TOP DRIVE® HTD - solid hub



TIMING PULLEYS - HD

## HD ... -14M55

14M

Code	Teeth nr.	Type	E [mm]	R [mm]	S [mm]	U [mm]	H [mm]	d [mm]	W [mm]	Y [mm]	Z [mm]	Flange	Material
HD 28 - 14M 55	28	1	128,0	124,78	122,12	-	100,0	-	70	85	15	with flanges	steel
HD 29 - 14M 55	29	1	138,0	129,23	126,57	-	107,0	-	70	85	15		
HD 30 - 14M 55	30	1	138,0	133,69	130,99	-	107,0	-	70	85	15		
HD 32 - 14M 55	32	1	154,0	142,60	139,88	-	114,0	-	70	85	15		
HD 34 - 14M 55	34	1	160,0	151,51	148,79	-	122,0	-	70	85	15		
HD 36 - 14M 55	36	1	168,0	160,43	157,68	-	128,0	-	70	85	15		
HD 38 - 14M 55	38	1	183,0	169,34	166,60	-	141,0	-	70	85	15		
HD 40 - 14M 55	40	1	198,0	178,25	175,49	-	148,0	-	70	85	15		
HD 44 - 14M 55	44	5	211,0	196,08	193,28	154	120,0	24	70	85	15		
HD 48 - 14M 55	48	7	226,0	213,90	211,11	172	135,0	24	70	70	-		
HD 56 - 14M 55	56	7	256,0	249,55	246,76	207	135,0	28	70	70	-		
HD 60 - 14M 55	60	7	275,0	267,38	264,59	225	135,0	28	70	70	-		
HD 64 - 14M 55	64	7	296,0	285,21	282,41	243	135,0	28	70	70	-		
HD 72 - 14M 55	72	7B	-	320,86	318,06	279	135,0	28	70	70	-		
HD 80 - 14M 55	80	7B	-	356,51	353,71	314	135,0	28	70	70	-		
HD 84 - 14M 55	84	7B	-	374,33	371,54	332	135,0	28	70	70	-		
HD 90 - 14M 55	90	7B	-	401,07	398,28	359	135,0	28	70	70	-		
HD 112 - 14M 55	112	7B	-	499,11	496,32	457	135,0	28	70	70	-		
HD 144 - 14M 55	144	7B	-	641,71	638,92	600	135,0	28	70	70	-		

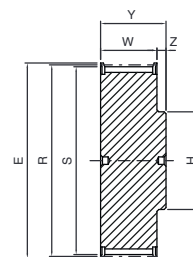

1

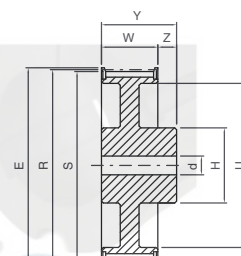

5

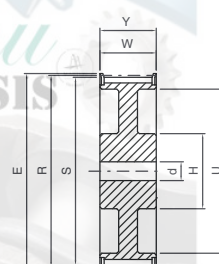

7

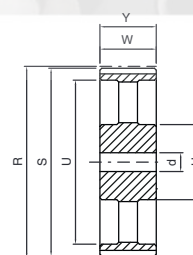

7B

## HD ... -14M85

14M

Code	Teeth nr.	Type	E [mm]	R [mm]	S [mm]	U [mm]	H [mm]	d [mm]	W [mm]	Y [mm]	Z [mm]	Flange	Material
HD 28 - 14M 85	28	1	128,0	124,78	122,12	-	100,0	-	102	117	15	with flanges	steel
HD 29 - 14M 85	29	1	138,0	129,23	126,57	-	107,0	-	102	117	15		
HD 30 - 14M 85	30	1	138,0	133,69	130,99	-	107,0	-	102	117	15		
HD 32 - 14M 85	32	1	154,0	142,60	139,88	-	114,0	-	102	117	15		
HD 34 - 14M 85	34	1	160,0	151,51	148,79	-	122,0	-	102	117	15		
HD 36 - 14M 85	36	1	168,0	160,43	157,68	-	128,0	-	102	117	15		
HD 38 - 14M 85	38	1	183,0	169,34	166,60	-	141,0	-	102	117	15		
HD 40 - 14M 85	40	1	198,0	178,25	175,49	-	148,0	-	102	117	15		
HD 44 - 14M 85	44	1	211,0	196,08	193,28	-	169,0	-	102	117	15		
HD 48 - 14M 85	48	1	226,0	213,90	211,11	-	186,0	-	102	117	15		
HD 56 - 14M 85	56	7	256,0	249,55	246,76	207	150,0	32	102	102	-		
HD 60 - 14M 85	60	7	275,0	267,38	264,59	225	150,0	32	102	102	-		
HD 64 - 14M 85	64	7	296,0	285,21	282,41	243	150,0	32	102	102	-		
HD 72 - 14M 85	72	7B	-	320,86	318,06	279	150,0	32	102	102	-		
HD 80 - 14M 85	80	7B	-	356,51	353,71	314	150,0	32	102	102	-		
HD 84 - 14M 85	84	7B	-	374,33	371,54	332	150,0	32	102	102	-		
HD 90 - 14M 85	90	7B	-	401,07	398,28	359	150,0	32	102	102	-		
HD 112 - 14M 85	112	7B	-	499,11	496,32	457	150,0	32	102	102	-		
HD 144 - 14M 85	144	7B	-	641,71	638,92	600	150,0	32	102	102	-		

# Dimensions of timing pulleys TOP DRIVE® HTD - solid hub



## HD ... -14M115

14M

Code	Teeth nr.	Type	E [mm]	R [mm]	S [mm]	U [mm]	H [mm]	d [mm]	W [mm]	Y [mm]	Z [mm]	Flange	Material
HD 28 - 14M 115	28	1	128,0	124,78	122,12	-	100,0	-	133	148	15	with flanges	steel
HD 29 - 14M 115	29	1	138,0	129,23	126,57	-	107,0	-	133	148	15		
HD 30 - 14M 115	30	1	138,0	133,69	130,99	-	107,0	-	133	148	15		
HD 32 - 14M 115	32	1	154,0	142,60	139,88	-	114,0	-	133	148	15		
HD 34 - 14M 115	34	1	160,0	151,51	148,79	-	122,0	-	133	148	15		
HD 36 - 14M 115	36	1	168,0	160,43	157,68	-	128,0	-	133	148	15		
HD 38 - 14M 115	38	1	183,0	169,34	166,60	-	141,0	-	133	148	15		
HD 40 - 14M 115	40	1	198,0	178,25	175,49	-	148,0	-	133	148	15		
HD 44 - 14M 115	44	1	211,0	196,08	193,28	-	169,0	-	133	148	15		
HD 48 - 14M 115	48	1	226,0	213,90	211,11	-	186,0	-	133	148	15		
HD 56 - 14M 115	56	5	256,0	249,55	246,76	207	150,0	32	133	148	15		
HD 60 - 14M 115	60	7	290,0	267,38	264,59	225	150,0	32	133	133	-		
HD 64 - 14M 115	64	7	296,0	285,21	282,41	243	150,0	32	133	133	-		
HD 72 - 14M 115	72	7B	-	320,86	318,06	279	150,0	32	133	133	-		
HD 80 - 14M 115	80	7B	-	356,51	353,71	314	150,0	32	133	133	-		
HD 84 - 14M 115	84	7B	-	374,33	371,54	332	150,0	32	133	133	-		
HD 90 - 14M 115	90	7B	-	401,07	398,28	359	150,0	32	133	133	-		
HD 112 - 14M 115	112	7B	-	499,11	496,32	457	150,0	32	133	133	-		
HD 144 - 14M 115	144	7B	-	641,71	638,92	600	150,0	32	133	133	-		

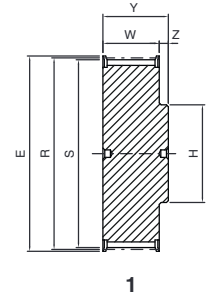

1

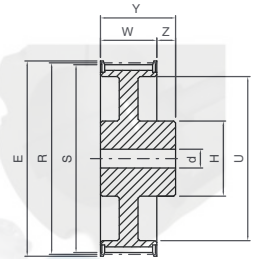

5

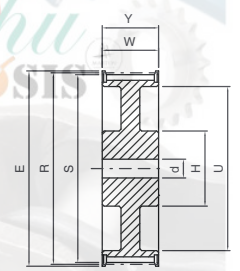

7

## HD ... -14M170

14M

Code	Teeth nr.	Type	E [mm]	R [mm]	S [mm]	U [mm]	H [mm]	d [mm]	W [mm]	Y [mm]	Z [mm]	Flange	Material
HD 28 - 14M 170	28	1	128,0	124,78	122,12	-	100,0	-	187	202	15	with flanges	steel
HD 29 - 14M 170	29	1	138,0	129,23	126,57	-	107,0	-	187	202	15		
HD 30 - 14M 170	30	1	138,0	133,69	130,99	-	107,0	-	187	202	15		
HD 32 - 14M 170	32	1	154,0	142,60	139,88	-	114,0	-	187	202	15		
HD 34 - 14M 170	34	1	160,0	151,51	148,79	-	122,0	-	187	202	15		
HD 36 - 14M 170	36	1	168,0	160,43	157,68	-	128,0	-	187	202	15		
HD 38 - 14M 170	38	1	183,0	169,34	166,60	-	141,0	-	187	202	15		
HD 40 - 14M 170	40	1	198,0	178,25	175,49	-	148,0	-	187	202	15		
HD 44 - 14M 170	44	1	211,0	196,08	193,28	-	169,0	-	187	202	15		
HD 48 - 14M 170	48	1	226,0	213,90	211,11	-	186,0	-	187	202	15		
HD 56 - 14M 170	56	5	256,0	249,55	246,76	207	160,0	32	187	202	15		
HD 60 - 14M 170	60	5	290,0	267,38	264,59	225	160,0	32	187	202	15		
HD 64 - 14M 170	64	5	296,0	285,21	282,41	243	180,0	32	187	202	15		
HD 72 - 14M 170	72	7A	-	320,86	318,06	279	180,0	32	187	187	-		
HD 80 - 14M 170	80	7A	-	356,51	353,71	314	180,0	32	187	187	-		
HD 84 - 14M 170	84	7B	-	374,33	371,54	332	180,0	32	187	187	-		
HD 90 - 14M 170	90	7B	-	401,07	398,28	359	180,0	32	187	187	-		
HD 112 - 14M 170	112	7B	-	499,11	496,32	456	200,0	32	187	187	-		
HD 144 - 14M 170	144	7B	-	641,71	638,92	600	220,0	32	187	187	-		

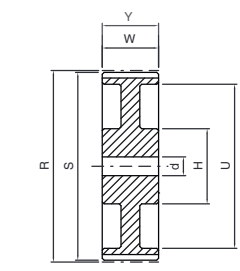

7A

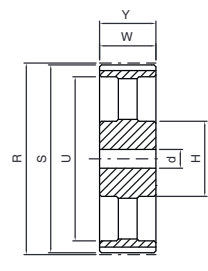

7B



# Dimensions of timing pulleys TOP DRIVE® HTD - mounting taper bushing SER-SIT® itches 5M - 8M - 14M



TIMING PULLEYS - HDB

**Part Number** **HDB 32 - 8M 20**

HTD pulley - mounting taper bushing

Number of teeth

Pitch

Belt width in mm

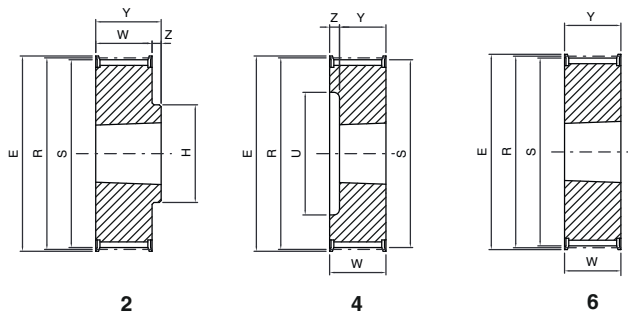

## HDB ... -5M15

Code	Teeth nr.	Type	SER-SIT® Taper bushing	E [mm]	R [mm]	S [mm]	U [mm]	H [mm]	W [mm]	Y [mm]	Z [mm]	Flange	Material
HDB 34 - 5M 15	34	6	1008	57,0	54,11	52,97	-	-	22	22	-	with flanges	steel
HDB 36 - 5M 15	36	6	1108	60,0	57,3	56,16	-	-	22	22	-		
HDB 38 - 5M 15	38	6	1108	66,5	60,48	59,34	-	-	22	22	-		
HDB 40 - 5M 15	40	6	1108	71,0	63,66	62,52	-	-	22	22	-		
HDB 44 - 5M 15	44	6	1108	75,0	70,03	68,89	-	-	22	22	-		
HDB 48 - 5M 15	48	2	1210	83,0	76,39	75,25	-	62,0	20,5	25	4,5		
HDB 56 - 5M 15	56	2	1210	93,0	89,13	87,99	-	70,0	20,5	25	4,5		
HDB 64 - 5M 15	64	2	1210	106,0	101,86	100,72	-	80,0	20,5	25	4,5		
HDB 72 - 5M 15	72	2	1610	119,0	114,59	113,45	-	92,0	20,5	25	4,5		
HDB 80 - 5M 15	80	2	1610	135,0	127,32	126,18	-	92,0	20,5	25	4,5		
HDB 90 - 5M 15	90	11A	1610	-	143,24	142,10	122	92,0	20,5	25	4,5	without flanges	cast iron
HDB 112 - 5M 15	112	11A	1610	-	178,25	177,11	157	110,0	20,5	25	4,5		
HDB 136 - 5M 15	136	11A	2012	-	216,45	215,31	195	110,0	20,5	32	5,8		
HDB 150 - 5M 15	150	11A	2012	-	238,73	237,59	217	110,0	20,5	32	5,8		

## 5M

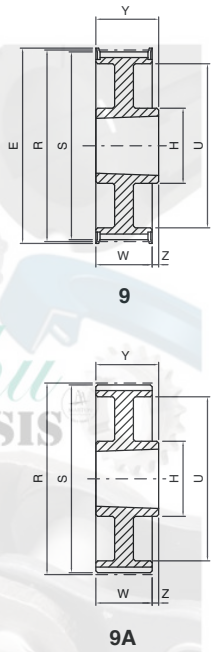

## HDB ... -8M20

Code	Teeth nr.	Type	SER-SIT® Taper bushing	E [mm]	R [mm]	S [mm]	U [mm]	H [mm]	W [mm]	Y [mm]	Z [mm]	Flange	Material
HDB 22 - 8M 20	22	4	1008	60,0	56,02	54,65	38	-	28	22	6	with flanges	steel
HDB 24 - 8M 20	24	4	1108	66,0	61,12	59,74	42	-	28	22	6		
HDB 26 - 8M 20	26	4	1108	70,0	66,21	64,84	45	-	28	22	6		
HDB 28 - 8M 20	28	4	1108	75,0	71,30	70,08	52	-	28	22	6		
HDB 30 - 8M 20	30	4	1108	83,0	76,39	75,13	56	-	28	22	6		
HDB 32 - 8M 20	32	4	1610	87,0	81,49	80,16	65	-	28	25	3		
HDB 34 - 8M 20	34	4	1610	91,0	86,58	85,21	66	-	28	25	3		
HDB 36 - 8M 20	36	4	1610	97,0	91,67	90,30	68	-	28	25	3		
HDB 38 - 8M 20	38	4	1610	102,0	96,77	95,39	76	-	28	25	3		
HDB 40 - 8M 20	40	4	1610	106,0	101,86	100,49	80	-	28	25	3		
HDB 44 - 8M 20	44	2	2012	120,0	112,05	110,67	-	93,0	28	32	4		
HDB 48 - 8M 20	48	2	2012	128,0	122,23	120,86	-	100,0	28	32	4		
HDB 56 - 8M 20	56	2	2012	150,0	142,60	141,23	-	110,0	28	32	4		
HDB 64 - 8M 20	64	9	2012	168,0	162,97	161,60	140	110,0	28	32	4		
HDB 72 - 8M 20	72	9	2012	192,0	183,35	181,97	158	110,0	28	32	4		
HDB 80 - 8M 20	80	9A	2012	-	203,74	202,35	178	110,0	28	32	4	without flanges	cast iron
HDB 90 - 8M 20	90	9B	2012	-	229,18	227,81	204	110,0	28	32	4		

## 8M

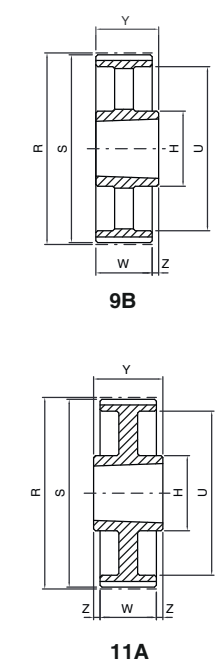

# Dimensions of timing pulleys TOP DRIVE® HTD - mounting taper bushing SER-SIT®



## HDB ... -8M30

8M

Code	Teeth nr.	Type	SER-SIT® Taper bushing	E [mm]	R [mm]	S [mm]	U [mm]	H [mm]	W [mm]	Y [mm]	Z [mm]	Flange	Material
HDB 22 - 8M 30	22	4	1008	60,0	56,02	54,65	38	-	38	22	16	with flanges	steel
HDB 24 - 8M 30	24	4	1108	66,0	61,12	59,74	42	-	38	22	16		
HDB 26 - 8M 30	26	4	1108	70,0	66,21	64,84	45	-	38	22	16		
HDB 28 - 8M 30	28	4	1108	75,0	71,30	70,08	52	-	38	22	16		
HDB 30 - 8M 30	30	6	1615	83,0	76,39	75,13	-	-	38	38	-		
HDB 32 - 8M 30	32	6	1615	87,0	81,49	80,16	-	-	38	38	-		
HDB 34 - 8M 30	34	6	1615	91,0	86,58	85,21	-	-	38	38	-		
HDB 36 - 8M 30	36	6	1615	97,0	91,67	90,30	-	-	38	38	-		
HDB 38 - 8M 30	38	6	1615	102,0	96,77	95,39	-	-	38	38	-		
HDB 40 - 8M 30	40	6	1615	106,0	101,86	100,49	-	-	38	38	-		
HDB 44 - 8M 30	44	5	2012	120,0	112,05	110,67	90	-	38	32	3		
HDB 48 - 8M 30	48	5	2012	128,0	122,23	120,86	100	-	38	32	3		
HDB 56 - 8M 30	56	5	2012	150,0	142,60	141,23	118	-	38	32	3		
HDB 64 - 8M 30	64	2	2517	168,0	162,97	161,60	140	125,0	38	45	7		
HDB 72 - 8M 30	72	9	2517	192,0	183,35	181,97	158	125,0	38	45	7		
HDB 80 - 8M 30	80	9A	2517	-	203,74	202,35	178	125,0	38	45	7		
HDB 90 - 8M 30	90	9B	2517	-	229,18	227,81	204	120,0	38	45	7		
HDB 112 - 8M 30	112	9B	2517	-	285,21	283,83	260	125,0	38	45	7		
HDB 144 - 8M 30	144	9B	2517	-	366,69	365,32	341	125,0	38	45	7		

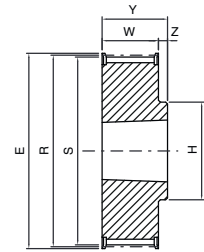

2

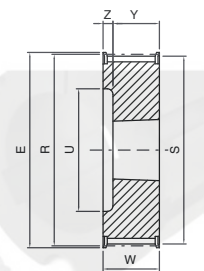

4

## HDB ... -8M50

8M

Code	Teeth nr.	Type	SER-SIT® Taper bushing	E [mm]	R [mm]	S [mm]	U [mm]	H [mm]	W [mm]	Y [mm]	Z [mm]	Flange	Material
HDB 28 - 8M 50	28	5	1108	75,0	71,30	70,08	52	-	60	22	19,0	with flanges	steel
HDB 30 - 8M 50	30	4	1615	83,0	76,39	75,13	58	-	60	38	22,0		
HDB 32 - 8M 50	32	4	1615	87,0	81,49	80,16	60	-	60	38	22,0		
HDB 34 - 8M 50	34	4	1615	91,0	86,58	85,21	66	-	60	38	22,0		
HDB 36 - 8M 50	36	4	1615	97,0	91,67	90,30	68	-	60	38	22,0		
HDB 38 - 8M 50	38	4	1615	102,0	96,77	95,39	75	-	60	38	22,0		
HDB 40 - 8M 50	40	5	2012	106,0	101,86	100,49	80	-	60	32	14,0		
HDB 44 - 8M 50	44	5	2012	120,0	112,05	110,67	90	-	60	32	14,0		
HDB 48 - 8M 50	48	5	2012	128,0	122,23	120,86	100	-	60	32	14,0		
HDB 56 - 8M 50	56	5	2517	150,0	142,60	141,23	120	-	60	45	7,5		
HDB 64 - 8M 50	64	8	2517	168,0	162,97	161,60	138	120,0	60	45	7,5		
HDB 72 - 8M 50	72	8	2517	192,0	183,35	181,97	158	125,0	60	45	7,5		
HDB 80 - 8M 50	80	8A	3020	-	203,74	202,35	178	160,0	60	51	4,5		
HDB 90 - 8M 50	90	8A	3020	-	229,18	227,81	204	170,0	60	51	4,5		
HDB 112 - 8M 50	112	8B	3020	-	285,21	283,83	260	170,0	60	51	4,5		
HDB 144 - 8M 50	144	8B	3020	-	366,69	365,32	341	170,0	60	51	4,5		
HDB 168 - 8M 50	168	8B	3020	-	427,80	426,42	402	198,0	60	51	4,5		
HDB 192 - 8M 50	192	8B	3020	-	488,92	487,54	462	198,0	60	51	4,5		

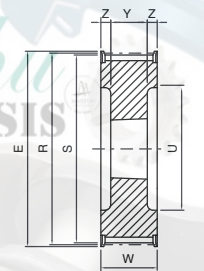

5

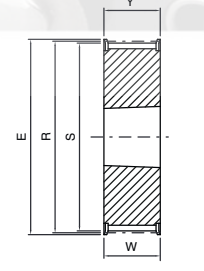

6

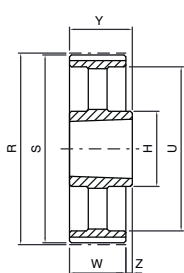

9B

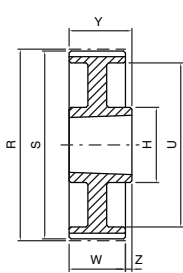

9A

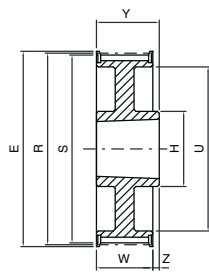

9

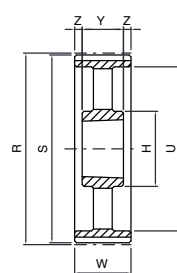

8B

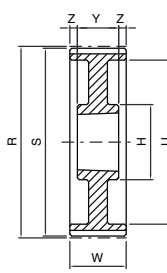

8A

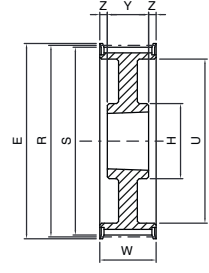

8

# Dimensions of timing pulleys TOP DRIVE® HTD - mounting taper bushing SER-SIT®



TIMING PULLEYS - HDB

## HDB ... -8M85

8M

Code	Teeth nr.	Type	SER-SIT® Taper bushing	E [mm]	R [mm]	S [mm]	U [mm]	H [mm]	W [mm]	Y [mm]	Z [mm]	Flange	Material
HDB 34 - 8M 85	34	5	1615	91,0	86,58	85,21	66	-	95	38	28,5	with flanges	steel
HDB 36 - 8M 85	36	5	1615	97,0	91,67	90,30	68	-	95	38	28,5		
HDB 38 - 8M 85	38	5	1615	102,0	96,77	95,39	75	-	95	38	28,5		
HDB 40 - 8M 85	40	5	2012	106,0	101,86	100,49	80	-	95	32	31,5		
HDB 44 - 8M 85	44	5	2012	120,0	112,05	110,67	90	-	95	32	31,5		
HDB 48 - 8M 85	48	5	2517	128,0	122,23	120,86	100	-	95	45	25,0		
HDB 56 - 8M 85	56	5	2517	150,0	142,60	141,23	120	-	95	45	25,0		
HDB 64 - 8M 85	64	5	2517	168,0	162,97	161,60	138	-	95	45	25,0		
HDB 72 - 8M 85	72	5	3020	192,0	183,35	181,97	158	-	95	51	22,0		
HDB 80 - 8M 85	80	8A	3020	-	203,74	202,35	178	160,0	95	51	22,0		
HDB 90 - 8M 85	90	8A	3020	-	229,18	227,81	204	170,0	95	51	22,0		
HDB 112 - 8M 85	112	8B	3020	-	285,21	283,83	260	170,0	95	51	22,0		
HDB 144 - 8M 85	144	8B	3030	-	366,69	365,32	341	198,0	95	76	9,5		
HDB 168 - 8M 85	168	8B	3030	-	427,80	426,42	402	198,0	95	76	9,5		
HDB 192 - 8M 85	192	8B	3030	-	488,92	487,54	462	198,0	95	76	9,5		

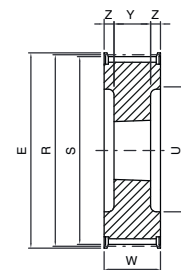

5

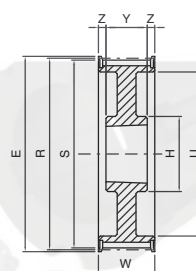

8

## HDB ... -14M40

14M

Code	Teeth nr.	Type	SER-SIT® Taper bushing	E [mm]	R [mm]	S [mm]	U [mm]	H [mm]	W [mm]	Y [mm]	Z [mm]	Flange	Material
HDB 28 - 14M 40	28	5	2012	128,0	124,78	122,12	98	-	54	32	11,0	with flanges	steel
HDB 29 - 14M 40	29	5	2012	138,0	129,23	126,57	100	-	54	32	11,0		
HDB 30 - 14M 40	30	5	2012	138,0	133,69	130,99	100	-	54	32	11,0		
HDB 32 - 14M 40	32	5	2012	154,0	142,60	139,88	104	-	54	32	11,0		
HDB 34 - 14M 40	34	5	2517	160,0	151,52	148,79	110	-	54	45	4,5		
HDB 36 - 14M 40	36	5	2517	168,0	160,43	157,68	120	-	54	45	4,5		
HDB 38 - 14M 40	38	5	2517	183,0	169,34	166,60	130	-	54	45	4,5		
HDB 40 - 14M 40	40	5	2517	188,0	178,25	175,49	138	-	54	45	4,5		
HDB 44 - 14M 40	44	5	3020	211,0	196,08	193,28	154	-	54	51	1,5		
HDB 48 - 14M 40	48	5	3020	226,0	213,90	211,11	172	-	54	51	1,5		
HDB 56 - 14M 40	56	8	3020	256,0	249,56	246,76	207	170,0	54	51	1,5		
HDB 64 - 14M 40	64	8	3020	296,0	285,21	282,41	243	170,0	54	51	1,5		
HDB 72 - 14M 40	72	8A	3020	-	320,86	318,06	279	170,0	54	51	1,5		
HDB 80 - 14M 40	80	8B	3020	-	356,51	353,71	315	170,0	54	51	1,5		
HDB 90 - 14M 40	90	8B	3020	-	401,07	398,28	359	170,0	54	51	1,5		
HDB 112 - 14M 40	112	8B	3020	-	499,11	496,32	457	170,0	54	51	1,5		
HDB 144 - 14M 40	144	8B	3020	-	641,71	638,92	600	170,0	54	51	1,5		
HDB 168 - 14M 40	168	8B	3020	-	748,66	745,87	705	160,0	54	51	1,5		
HDB 192 - 14M 40	192	9B	3535	-	855,62	852,82	812	178,0	54	89	35		
HDB 216 - 14M 40	216	9B	3535	-	962,57	959,77	920	178,0	54	89	35		
HDB 264 - 14M 40	264	9B	3535	-	1176,47	1173,67	1133	178,0	54	89	35		

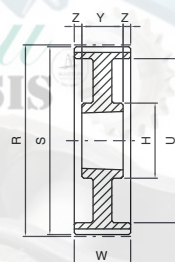

8A

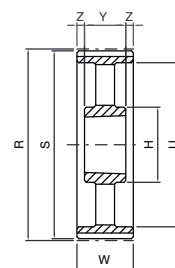

8B

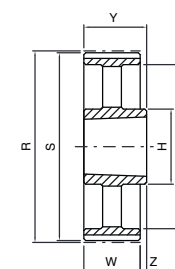

9B

# Dimensions of timing pulleys TOP DRIVE® HTD - mounting taper bushing SER-SIT®



## HDB ... -14M55

14M

Code	Teeth nr.	Type	SER-SIT® Taper bushing	E [mm]	R [mm]	S [mm]	U [mm]	H [mm]	W [mm]	Y [mm]	Z [mm]	Flange	Material
HDB 28 - 14M 55	28	5	2012	128,0	124,78	122,12	98	-	70	32	19,0	with flanges	steel
HDB 29 - 14M 55	29	5	2012	138,0	129,23	126,57	100	-	70	32	19,0		
HDB 30 - 14M 55	30	5	2517	138,0	133,69	130,99	100	-	70	45	12,5		
HDB 32 - 14M 55	32	5	2517	154,0	142,60	139,88	104	-	70	45	12,5		
HDB 34 - 14M 55	34	5	2517	160,0	151,52	148,79	110	-	70	45	12,5		
HDB 36 - 14M 55	36	5	2517	168,0	160,43	157,68	120	-	70	45	12,5		
HDB 38 - 14M 55	38	5	2517	183,0	169,34	166,60	130	-	70	45	12,5		
HDB 40 - 14M 55	40	5	2517	188,0	178,25	175,49	138	-	70	45	12,5		
HDB 44 - 14M 55	44	5	3020	211,0	196,08	193,28	154	-	70	51	9,5		
HDB 48 - 14M 55	48	5	3020	226,0	213,90	211,11	172	-	70	51	9,5		
HDB 56 - 14M 55	56	8	3020	256,0	249,56	246,76	207	170,0	70	51	9,5		
HDB 64 - 14M 55	64	8	3020	296,0	285,21	282,41	243	170,0	70	51	9,5		
HDB 72 - 14M 55	72	8A	3020	-	320,86	318,06	279	170,0	70	51	9,5		
HDB 80 - 14M 55	80	8B	3020	-	356,51	353,71	314	170,0	70	51	9,5		
HDB 90 - 14M 55	90	8B	3020	-	401,07	398,28	359	170,0	70	51	9,5		
HDB 112 - 14M 55	112	8B	3020	-	499,11	496,32	457	170,0	70	51	9,5		
HDB 144 - 14M 55	144	8B	3020	-	641,71	638,92	600	170,0	70	51	9,5		
HDB 168 - 14M 55	168	8B	3020	-	748,66	745,87	705	160,0	70	51	9,5		
HDB 192 - 14M 55	192	9B	3535	-	855,62	852,82	812	178,0	70	89	19,0		
HDB 216 - 14M 55	216	9B	3535	-	962,57	959,77	920	178,0	70	89	19,0		
HDB 264 - 14M 55	264	9B	3535	-	1176,47	1173,67	1133	178,0	70	89	19,0		

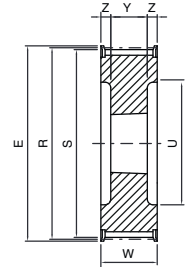

5

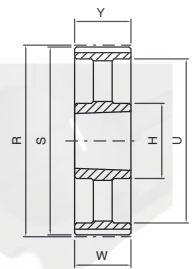

7B

## HDB ... -14M85

14M

Code	Teeth nr.	Type	SER-SIT® Taper bushing	E [mm]	R [mm]	S [mm]	U [mm]	H [mm]	W [mm]	Y [mm]	Z [mm]	Flange	Material
HDB 28 - 14M 85	28	5	2517	128,0	124,78	122,12	98	-	102	45	28,5	with flanges	steel
HDB 29 - 14M 85	29	5	2517	138,0	129,23	126,57	100	-	102	45	28,5		
HDB 30 - 14M 85	30	5	2517	138,0	133,69	130,99	100	-	102	45	28,5		
HDB 32 - 14M 85	32	5	2517	154,0	142,60	139,88	104	-	102	45	28,5		
HDB 34 - 14M 85	34	5	2517	160,0	151,52	148,79	110	-	102	45	28,5		
HDB 36 - 14M 85	36	5	3020	168,0	160,43	157,68	120	-	102	51	25,5		
HDB 38 - 14M 85	38	5	3020	183,0	169,34	166,60	130	-	102	51	25,5		
HDB 40 - 14M 85	40	5	3020	188,0	178,25	175,49	138	-	102	51	25,5		
HDB 44 - 14M 85	44	5	3030	211,0	196,08	193,28	154	-	102	76	13,0		
HDB 48 - 14M 85	48	5	3030	226,0	213,90	211,11	172	-	102	76	13,0		
HDB 56 - 14M 85	56	5	3535	256,0	249,56	246,76	207	-	102	89	6,5		
HDB 64 - 14M 85	64	8	3535	296,0	285,21	282,41	243	178,0	102	89	6,5		
HDB 72 - 14M 85	72	8A	3535	-	320,86	318,06	279	178,0	102	89	6,5		
HDB 80 - 14M 85	80	8B	3535	-	356,51	353,71	314	190,0	102	89	6,5		
HDB 90 - 14M 85	90	8B	3535	-	401,07	398,28	359	190,0	102	89	6,5		
HDB 112 - 14M 85	112	8B	3535	-	499,11	496,32	457	178,0	102	89	6,5		
HDB 144 - 14M 85	144	8B	3535	-	641,71	638,92	600	190,0	102	89	6,5		
HDB 168 - 14M 85	168	8B	3535	-	748,66	745,87	705	178,0	102	89	6,5		
HDB 192 - 14M 85	192	7B	4040	-	855,62	852,82	812	215,0	102	102	-		
HDB 216 - 14M 85	216	7B	4040	-	962,57	959,77	920	215,0	102	102	-		
HDB 264 - 14M 85	264	7B	4040	-	1176,47	1173,67	1133	215,0	102	102	-		

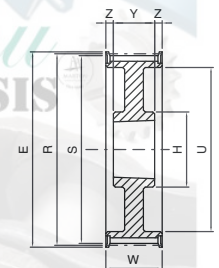

8

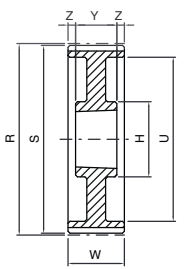

8A

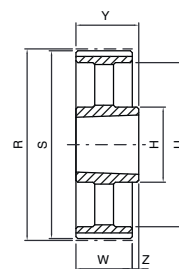

9B

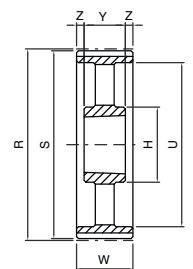

8B

# Dimensions of timing pulleys TOP DRIVE® HTD - mounting taper bushing SER-SIT®



TIMING PULLEYS - HDB

## HDB ... -14M115

14M

Code	Teeth nr.	Type	SER-SIT® Taper bushing	E [mm]	R [mm]	S [mm]	U [mm]	H [mm]	W [mm]	Y [mm]	Z [mm]	Flange	Material
HDB 28 - 14M 115	28	5	2517	128,0	124,78	122,12	98	-	133	45	44,0	with flanges	steel
HDB 29 - 14M 115	29	5	2517	138,0	129,23	126,57	100	-	133	45	44,0		
HDB 30 - 14M 115	30	5	2517	138,0	133,69	130,99	100	-	133	45	44,0		
HDB 32 - 14M 115	32	5	2517	154,0	142,60	139,88	104	-	133	45	44,0		
HDB 34 - 14M 115	34	5	2517	160,0	151,52	148,79	110	-	133	45	44,0		
HDB 36 - 14M 115	36	5	3020	168,0	160,43	157,68	120	-	133	51	41,0		
HDB 38 - 14M 115	38	5	3020	183,0	169,34	166,60	130	-	133	51	41,0		
HDB 40 - 14M 115	40	5	3020	188,0	178,25	175,49	138	-	133	51	41,0		
HDB 44 - 14M 115	44	5	3030	211,0	196,08	193,28	154	-	133	76	28,5		
HDB 48 - 14M 115	48	5	3030	226,0	213,90	211,11	172	-	133	76	28,5		
HDB 56 - 14M 115	56	5	3535	256,0	249,56	246,76	207	-	133	89	22,0		
HDB 64 - 14M 115	64	8	3535	296,0	285,21	282,41	243	178,0	133	89	22,0		
HDB 72 - 14M 115	72	8A	3535	-	320,86	318,06	279	178,0	133	89	22,0		
HDB 80 - 14M 115	80	8B	3535	-	356,51	353,71	314	178,0	133	89	22,0		
HDB 90 - 14M 115	90	8B	3535	-	401,07	398,28	359	178,0	133	89	22,0		
HDB 112 - 14M 115	112	8B	3535	-	499,11	496,32	457	178,0	133	89	22,0		
HDB 144 - 14M 115	144	8B	4040	-	641,71	638,92	600	230,0	133	102	15,5		
HDB 168 - 14M 115	168	8B	4040	-	748,66	745,87	705	215,0	133	102	15,5		
HDB 192 - 14M 115	192	8B	4040	-	855,62	852,82	812	215,0	133	102	15,5		
HDB 216 - 14M 115	216	8B	4040	-	962,57	959,77	920	215,0	133	102	15,5		
HDB 264 - 14M 115	264	8B	5050	-	1176,47	1173,67	1133	267,0	133	127	3,0		

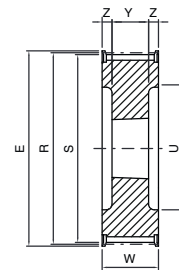

5

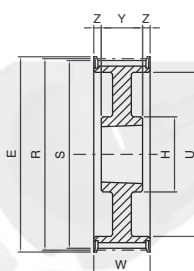

8



HAJTASTECHNIKA powered by SIS

## HDB ... -14M170

14M

Code	Teeth nr.	Type	SER-SIT® Taper bushing	E [mm]	R [mm]	S [mm]	U [mm]	H [mm]	W [mm]	Y [mm]	Z [mm]	Flange	Material
HDB 38 - 14M 170	38	5	3030	183,0	169,34	166,60	130	-	187	76	55,5	with flanges	steel
HDB 40 - 14M 170	40	5	3030	188,0	178,25	175,49	138	-	187	76	55,5		
HDB 44 - 14M 170	44	5	3535	211,0	196,08	193,28	154	-	187	89	49,0		
HDB 48 - 14M 170	48	5	3535	226,0	213,90	211,11	172	-	187	89	49,0		
HDB 56 - 14M 170	56	5	3535	256,0	249,56	246,76	207	-	187	89	49,0		
HDB 64 - 14M 170	64	5	4040	296,0	285,21	282,41	243	-	187	102	42,5		
HDB 72 - 14M 170	72	8A	4040	-	320,86	318,06	280	230,0	187	102	42,5		
HDB 80 - 14M 170	80	8A	4040	-	356,51	353,71	314	230,0	187	102	42,5		
HDB 90 - 14M 170	90	8B	4040	-	401,07	398,28	359	230,0	187	102	42,5		
HDB 112 - 14M 170	112	8B	5050	-	499,11	496,32	457	265,0	187	127	30,0		
HDB 144 - 14M 170	144	8B	5050	-	641,71	638,92	600	265,0	187	127	30,0		
HDB 168 - 14M 170	168	8B	5050	-	748,66	745,87	705	267,0	187	127	30,0		
HDB 192 - 14M 170	192	8B	5050	-	855,62	852,82	812	267,0	187	127	30,0		
HDB 216 - 14M 170	216	8B	5050	-	962,57	959,77	920	267,0	187	127	30,0		
HDB 264 - 14M 170	264	8B	5050	-	1176,47	1173,67	1133	267,0	187	127	30,0		

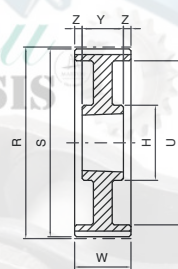

8A

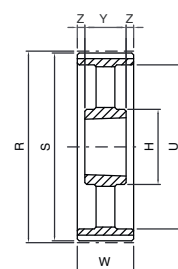

8B