

HERE'S A CHALLENGE ...

# Who's got the Perfect Spin to bowl your customers over?

## CHALLENGE X Series Spin Riveted Transmission Chain

Never a  
problem  
always a ...



**Spin Riveted For  
Added Strength**



**Lock in to:**

Secure source of supply • Superior service  
Product quality and reliability • Manufacturers prices  
*Securing more than just your profits*

Never a problem always a ...

# CHALLENGE®

[www.challengept.com](http://www.challengept.com)



# Roller Chain



## The Benefits...

### CHALLENGE X Series Transmission Chain

- **Spin Riveted Case Hardened Pins in Alloy Steel** - For optimum life
- **Pre-stretched** - Fit and forget
- **Ball swaged holes** - Combats fatigue
- **Shot peened** - Produces strong surface and reduced fatigue
- **Deep waisted side plates** - Reduces stress
- **Rollers from seamless tube** - For strength and long life

### The X Series Range...

British standard		American standard	
20B-1X	32B-2X	100-1X	180-1X
20B-1GLX	32B-3X	100-2X	180-2X
20B-2X	40B-1X	100-3X	180-3X
20B-2GLX	40B-1GLX	120-1X	200-1X
20B-3X	40B-2X	120-1X	200-2X
20B-3GLX	40B-3X	120-1X	200-3X
24B-1X	48B-1X	140-1X	240-1X
24B-1GLX	48B-1GLX	140-2X	240-2X
24B-2X	48B-2X	140-3X	240-3X
24B-3X	48B-3X	160-1X	
28B-1X	56B-1X	160-2X	
28B-1GLX	56B-2X	160-2X	
28B-2X	56B-3X		
28B-3X	64B-1X		
32B-1X	64B-2X		
32B-1GLX	64B-3X		

## Also in the Roller Chain range

#### Roller Chain

- British Standard Roller Chain
- ANSI Standard Roller Chain
- ANSI Heavy Duty Roller Chain
- ANSI Cottered Series Roller Chain
- ANSI Cottered Heavy Duty Series Roller Chain
- ANSI Straight Side Plate Roller Chain
- British Standard Straight Side Plate Roller Chain
- Chain Breakers
- Timing Chain
- Bush Chain
- Bicycle Chain
- Bicycle Chain/Connecting Links
- Roller Chain with Extended Pins
- Special Transmission Roller Chain
- Hollow Pin Roller Chain
- Special Chain with "U" Elements
- Special Chain with "U" and Rubber Elements
- Transport Chain
- Special Chain with Driver
- Stainless Steel Transmission Roller Chain
- Side Bow Chain
- Nickel & Zinc Plated Transmission Roller Chain
- Roller Chain Attachments

#### Double Pitch Chain

- Double Pitch Transmission Chain
- Double Pitch Conveyor Chain
- Double Pitch Attachments
- Double Pitch Special Chain
- Double Pitch Extended Pin Chain
- Double Pitch Hollow Pin Chain

#### Leaf Chain

- LH / BL Series Leaf Chain
- LL Series Leaf Chain
- AL Series Leaf Chain
- FL Series Leaf Chain
- Clevis Pins
- Special Leaf Chain with Hollow Pin

#### Timber Chain

- Welded Steel Chain
- Welded Steel Chain Attachments (offset sidebar)
- Welded Steel Chain (offset side bar)
- Offset Sidebar Roller Chain
- Straight Sidebar Roller Chain
- Welded Steel Drag Chain
- Drag Chain Attachments

#### Agricultural Chain

- Steel Agricultural Chain
- Agricultural Chain Attachments

#### Conveyor Chain

- BS Z Series with Solid Pin Chain
- BS ZC Series with Hollow Pin Chain
- BS Z/ZC Series Attachments Chain
- BS ZE Series Deep Link Chain
- M Series Metric Solid Pin Chain
- M Series Chain Attachments
- MC Series Hollow Pin Chain
- MT/ME Series Deep Link Chain
- FV/C Series Metric Solid Pin Chain
- FV/C Series Metric Hollow Pin Chain
- FV/C Series Chain Attachments
- FVT/CE Series Metric Deep Link Chain
- FV/CR Series Metric Scraper Chain
- Special Conveyor Chain
- Special Conveyor Chain
- Conveyor Chain Attachment Chain Designations

# Roller Chain Attachments

## A-1 & K-1 Attachments

ISO No.	ANSI No.	P	I	J	K	L	M	O
	40	12.700	9.50	25.40	35.20	1.50	7.90	3.40
	50	15.875	12.70	31.75	46.20	2.03	10.30	5.50
	60	19.050	15.90	38.10	55.60	2.42	11.90	5.50
	80	25.400	19.10	50.80	64.80	3.25	15.90	6.80
	100	31.750	25.40	63.50	87.30	4.00	19.80	9.20
	120	38.100	28.60	76.20	108.50	4.80	23.00	9.80
	140	44.450	34.90	88.90	123.00	5.60	28.60	11.40
	160	50.800	38.10	101.60	142.80	6.40	31.80	13.10
	*06B	9.525	8.00	19.04	27.00	1.30	6.50	3.50
	08B	12.700	9.50	25.40	36.40	1.60	8.90	4.50
	10B	15.875	14.30	31.75	44.60	1.70	10.31	5.30
	12B	19.050	16.00	38.10	52.40	1.85	13.46	6.40
	16B	25.400	19.10	50.80	72.60	3.10	15.88	6.40

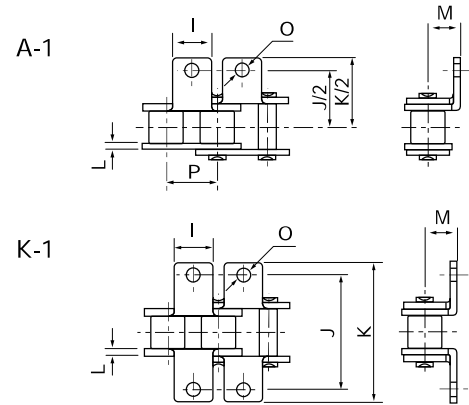

## SA-1 & SK-1 Attachments

ISO No.	ANSI No.	P	I	J	Q	L	O
	40	12.700	9.50	19.05	12.70	1.50	3.40
	50	15.875	12.70	25.25	15.90	2.03	5.50
	60	19.050	15.90	29.33	18.30	2.42	5.50
	80	25.400	19.10	34.70	24.60	3.25	6.80
	100	31.750	25.40	43.30	31.80	4.00	9.20
	120	38.100	28.60	51.60	36.50	4.80	9.80
	140	44.450	34.90	62.00	44.50	5.60	11.40
	160	50.800	38.10	69.85	50.80	6.40	13.10
	*06B	9.525	8.00	13.50	9.52	1.30	3.50
	08B	12.700	9.50	18.90	13.35	1.60	4.30
	10B	15.875	14.30	22.95	16.50	1.70	5.30
	12B	19.050	16.00	28.60	21.45	1.85	6.40
	16B	25.400	19.10	34.00	23.15	3.10	6.40

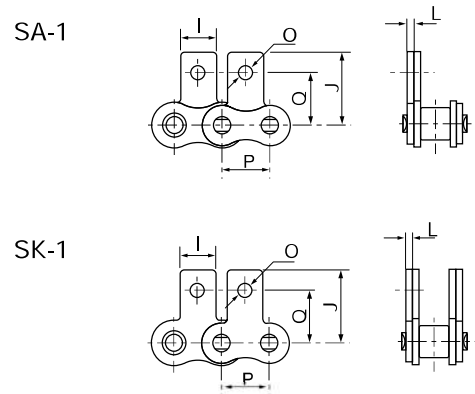

## WA-2 & WK-2 Attachments

ISO No.	ANSI No.	P	I	R	J	K	L	M	O
	40	12.700	23.00	12.70	25.40	35.60	1.50	7.90	3.40
	50	15.875	28.80	15.88	31.80	46.80	2.03	10.30	5.50
	60	19.050	34.65	19.05	38.10	56.40	2.42	11.90	5.50
	80	25.400	45.90	25.40	50.80	73.20	3.25	15.90	6.80
	100	31.750	57.65	31.75	63.50	89.80	4.00	19.80	9.20
	08B	12.700	24.00	12.70	25.40	36.40	1.60	8.90	4.30
	10B	15.875	29.58	15.88	31.80	44.60	1.70	10.31	5.30
	12B	19.050	34.05	19.05	38.10	52.40	1.85	13.46	6.40
	16B	25.400	46.40	25.40	50.80	72.60	3.10	15.88	6.40

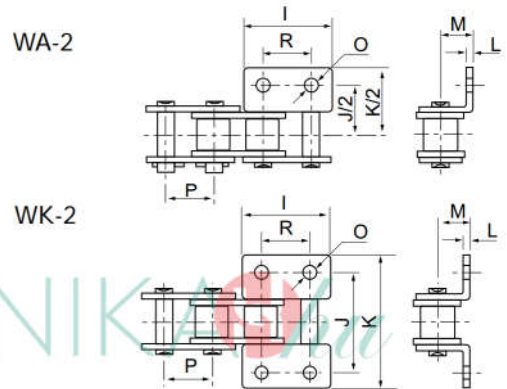

## WSA-2 & WSK-2 Attachments

ISO No.	ANSI No.	P	I	R	J	Q	L	O
	40	12.700	23.00	12.70	17.40	12.70	1.50	3.40
	50	15.875	28.80	15.88	23.05	15.90	2.03	5.50
	60	19.050	34.65	19.05	26.86	18.30	2.42	5.50
	80	25.400	45.90	25.40	35.45	24.60	3.25	6.80
	100	31.750	57.65	31.75	44.00	31.80	4.00	9.20
	08B	12.700	23.30	12.70	18.90	13.35	1.60	4.30
	10B	15.875	29.58	15.88	22.95	16.50	1.70	5.30
	12B	19.050	34.05	19.05	28.60	21.45	1.85	6.40
	16B	25.400	46.40	25.40	34.00	23.15	3.10	6.40

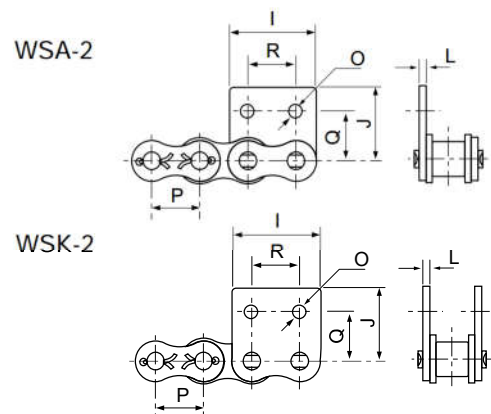

\* Straight side plates

All dimensions in millimetres unless otherwise stated. Every effort has been taken to ensure that the data listed in this catalogue is correct. Challenge accepts no liability for any inaccuracies or damage caused.

# Roller Chain Attachments

## Attachment Chain Designation

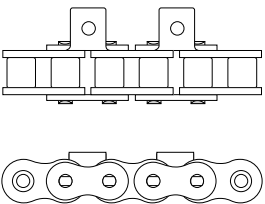
1. Standard Chains with bent attachment A1 - one hole - one side - every outer	
	Chain Reference
	06BA-2
	08BA-2
	10BA-2
	12BA-2
16BA-2	

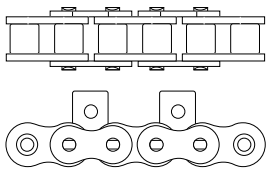
7. Standard Chains with straight attachment SA1 - one hole - one side - every outer	
	Chain Reference
	06BSA-2
	08BSA-2
	10BSA-2
	12BSA-2
16BSA-2	

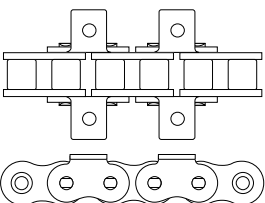
2. Standard Chains with bent attachment K1 - one hole - both sides - every outer	
	Chain Reference
	06BK-2
	08BK-2
	10BK-2
	12BK-2
16BK-2	

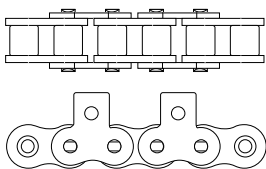
8. Standard Chains with straight attachment SK1 - one hole - both sides - every outer	
	Chain Reference
	06BSK-2
	08BSK-2
	10BSK-2
	12BSK-2
16BSK-2	

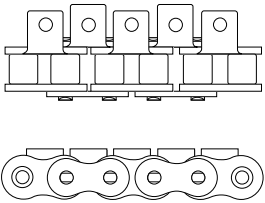
3. Standard Chains with bent attachment A1 - one hole - one side - every outer and inner	
	Chain Reference
	06BA-1
	08BA-1
	10BA-1
	12BA-1
16BA-1	

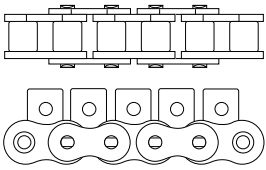
9. Standard Chains with straight attachment SA1 - one hole - one side - every outer and inner	
	Chain Reference
	06BSA-1
	08BSA-1
	10BSA-1
	12BSA-1
16BSA-1	

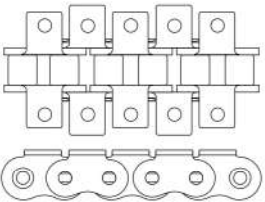
4. Standard Chains with bent attachment K1 - one hole - both sides - every outer and inner	
	Chain Reference
	06BK-1
	08BK-1
	10BK-1
	12BK-1
16BK-1	

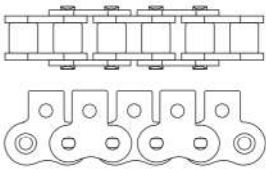
10. Standard Chains with straight attachment SK1 - one hole - both sides - every outer and inner	
	Chain Reference
	06BSK-1
	08BSK-1
	10BSK-1
	12BSK-1
16BSK-1	

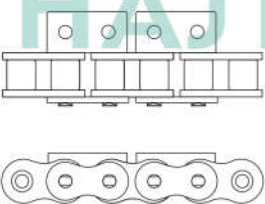
5. Standard Chains with bent attachment WA2 - two holes - one side - every outer	
	Chain Reference
	06BWA-2
	08BWA-2
	10BWA-2
	12BWA-2
16BWA-2	

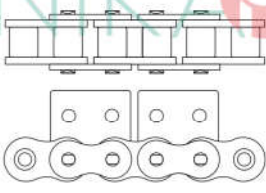
11. Standard Chains with straight attachment WSA2 - two holes - one side - every outer	
	Chain Reference
	06BWSA-2
	08BWSA-2
	10BWSA-2
	12BWSA-2
16BWSA-2	

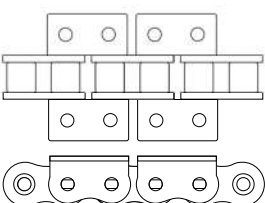
6. Standard Chains with bent attachment WK2 - two holes - both sides - every outer	
	Chain Reference
	06BWK-2
	08BWK-2
	10BWK-2
	12BWK-2
16BWK-2	

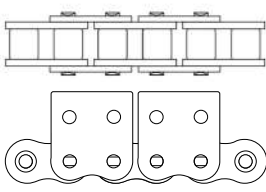
12. Standard Chains with straight attachment WSK2 - two holes - both sides - every outer	
	Chain Reference
	06WSK-2
	08BWSK-2
	10BWSK-2
	12BWSK-2
16BWSK-1	

Standard boxed lengths are 5 metres or 10 feet.  
Special lengths available.

Every effort has been taken to ensure that the data listed in this catalogue is correct. Challenge accepts no liability for any inaccuracies or damage caused. All dimensions in millimetres unless otherwise stated.